

TYPICAL SECTION IN L-SHAPED RETAINING WALL

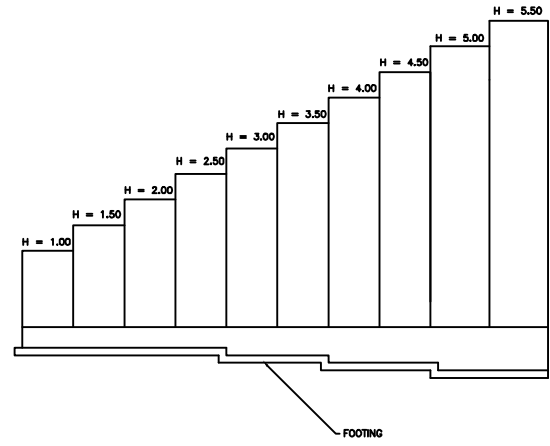
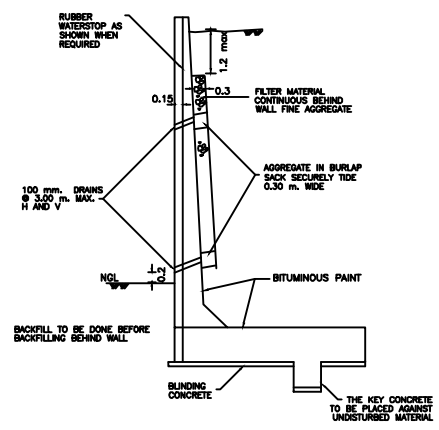

ELEVATION

- NOTES**
1. ALL DIMENSIONS ARE IN METERS UNLESS OTHERWISE INDICATED.
 2. ALL BAR SIZES ARE IN MILLIMETERS.
 3. COST OF :
 - a. BITUMEN
 - b. FILTER MATERIAL
 - c. JOINTS COMPLETE
 - d. WATER STOP
 - e. DRAIN
 4. COST OF REINFORCED CONCRETE INCLUDE ALL COSTS OF FORMWORK AND STEEL WITH ALL SIZES
 5. IF SOIL IS NOT SUITABLE TOE AVERAGE PRESSURE SHOWN, MASS CONCRETE TO REQUIRED DEPTH IS TO BE CAST UNDER FOOTING AS INSTRUCTED BY THE ENGINEER.
 6. THE CONTRACTOR MUST SUBMIT A VERY DETAILED SURVEY FOR EVERY LOCATION OF RETAINING WALLS TO DEFINE THE EXACT EXTENT AND HEIGHTS.
 7. DRAIN AND FILTER MATERIAL AND DRAIN PIPE ETC. TO BE INCLUDED IN UNIT RATES OF R.C.C. FOR ALL WALLS AND ABUTMENTS AS SHOWN

TABLE OF REINFORCING STEEL, DIMENSIONS AND DATA L-SHAPED RETAINING WALL										
H m.	1.0	1.5	2.0	2.5	3.0	3.5	4.0	5.0	5.5	6
W m.	1.35	1.50	1.90	2.15	2.45	2.80	3.00	3.20	3.4	3.8
B m.	0.25	0.25	0.25	0.30	0.35	0.40	0.45	0.50	0.55	0.60
D m.	0.70	0.70	0.75	0.80	0.85	0.90	0.95	1.00	1.05	1.1
M m.	0.25	0.25	0.30	0.40	0.40	0.40	0.40	0.45	0.50	0.55
L m.	0.25	0.25	0.35	0.50	0.65	0.75	0.80	0.90	1.00	1.10
N m.	0.20	0.20	0.20	0.30	0.30	0.30	0.30	0.35	0.40	0.45
"a" BARS Φ	10/15	10/12.5	10/12.5	12/15	12/15	14/17.5	14/15	14/12.5	14/10	16/12.5
"b" BARS Φ	10/15	10/12.5	10/12.5	12/15	14/15	16/17.5	16/15	16/12.5	16/10	18/12.5
"c" BARS Φ	10/15	10/12.5	10/12.5	12/15	14/15	16/15	18/15	18/12.5	20/10	25/12.5
"d" BARS Φ	-	-	-	10/20	10/20	12/20	12/20	14/20	16/20	16/20
CONCRETE	C _u M									
Per m run										

- BAR SIZES ARE IN MILLIMETERS.
 - BARE SPACINGS ARE IN CENTIMETERS.
 - ALLOWABLE BEARING SOIL PRESSURE q_u = 2Kg/cm²

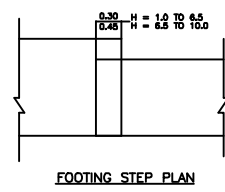

FOOTING STEP PLAN

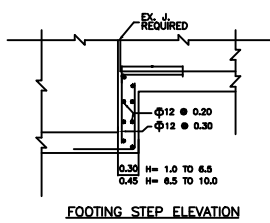

FOOTING STEP ELEVATION

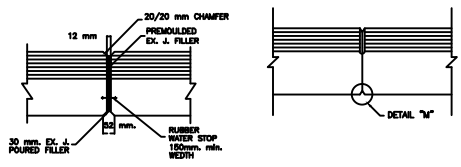

EXPANSION JOINT PLAN

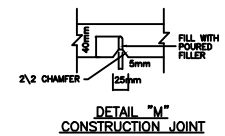

DETAIL "M" CONSTRUCTION JOINT

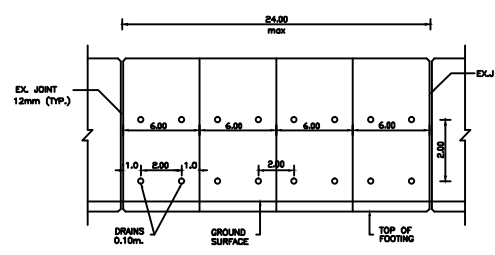

ELEVATION

REVISION	DATE	DESCRIPTION	BY

HASHEMITE KINGDOM OF JORDAN

PETRA REGION AUTHORITY
 DIRECTORATE
 ENGINEERING & TECHNICALITY SERVICES

STANDARD DETAILS
 L-SHAPE RETAINING WALL
 DETAILS

Gararah R Wall

SCALE
DATE