

Petra

Petra Development & Tourism Region Authority

Rajef

2017

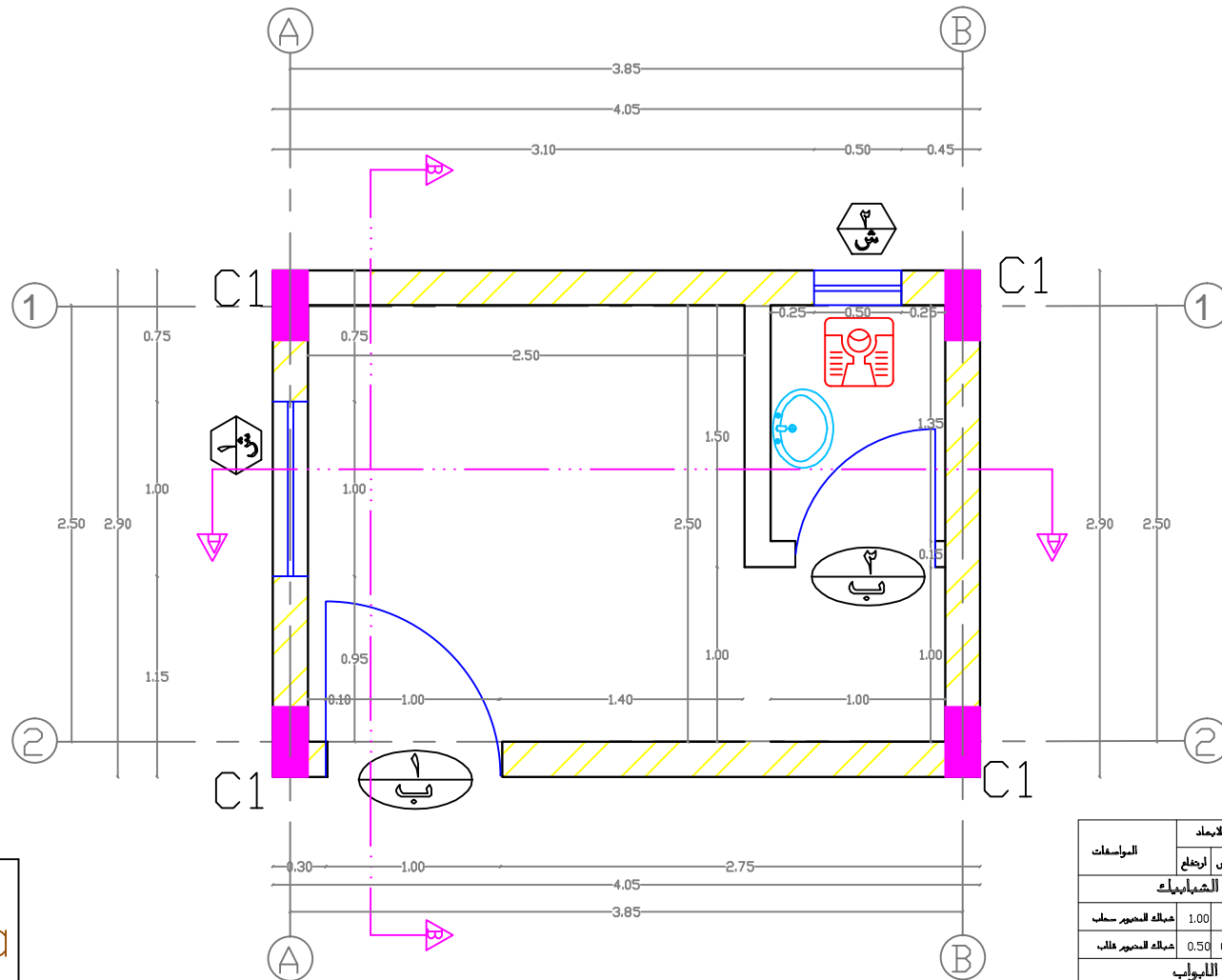

المواصفات	الأبعاد		الرقم
	الارتفاع	عرض	
فتحات الشبكات			
غرفة التصوير حطب	1.00	1.00	1
غرفة التصوير حطب	0.50	0.50	2
فتحات النوافذ			
باب درفة واحدة حديد قاسين	2.00	1.00	1
باب درفة واحدة خشب	2.00	0.80	2



Petra
Petra Development & Tourism Region Authority

Najaf Security Room

Architecture plan

Scale: 1:50

Author: Eng. Safaa Amerat

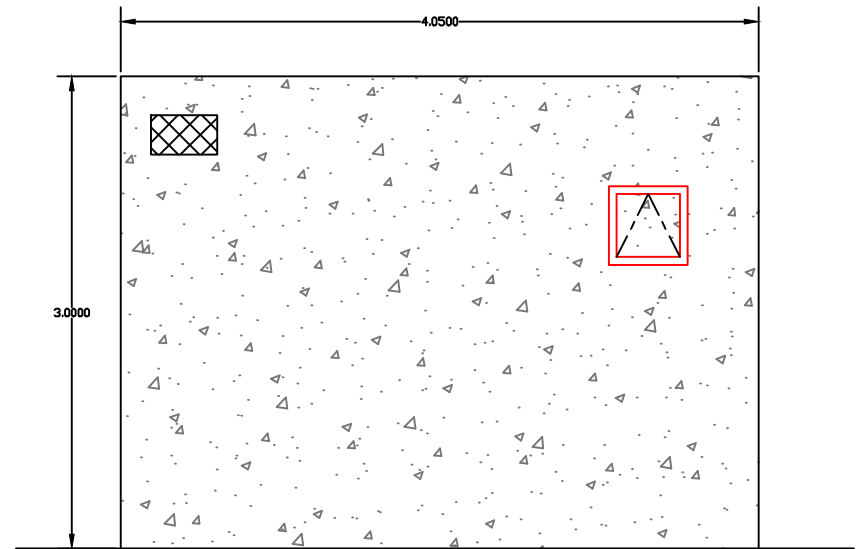
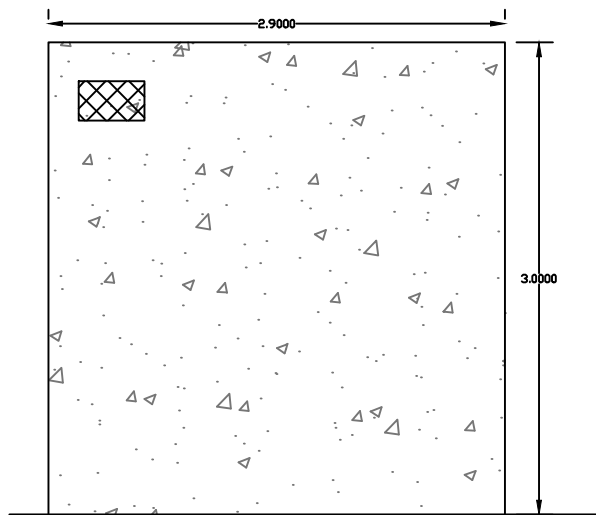
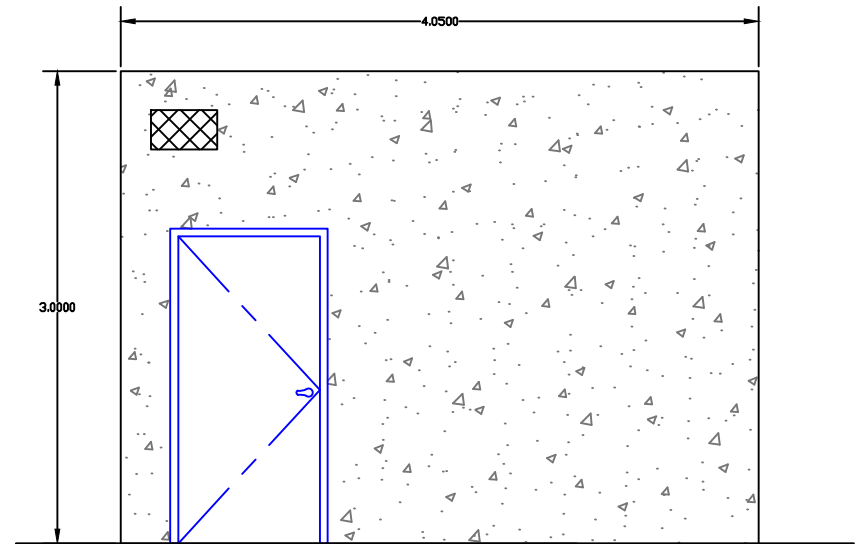
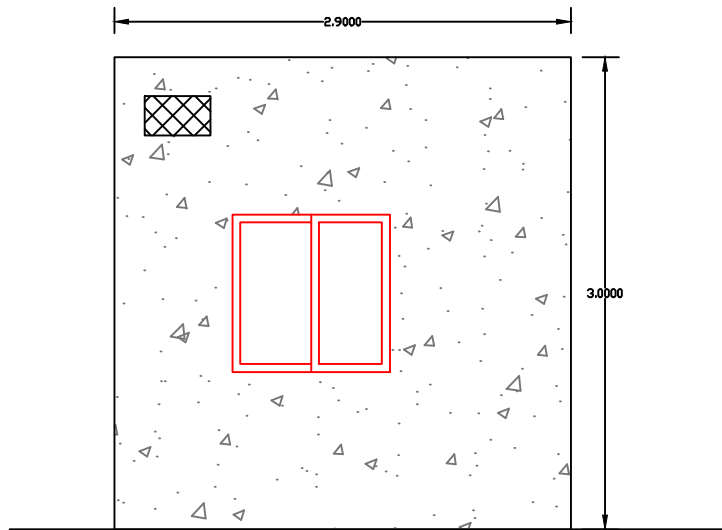

Petra
Petra Development & Tourism Region Authority

Project Security Room	
Architectural plan	
Scale	1:50
Revision	01 - Initial

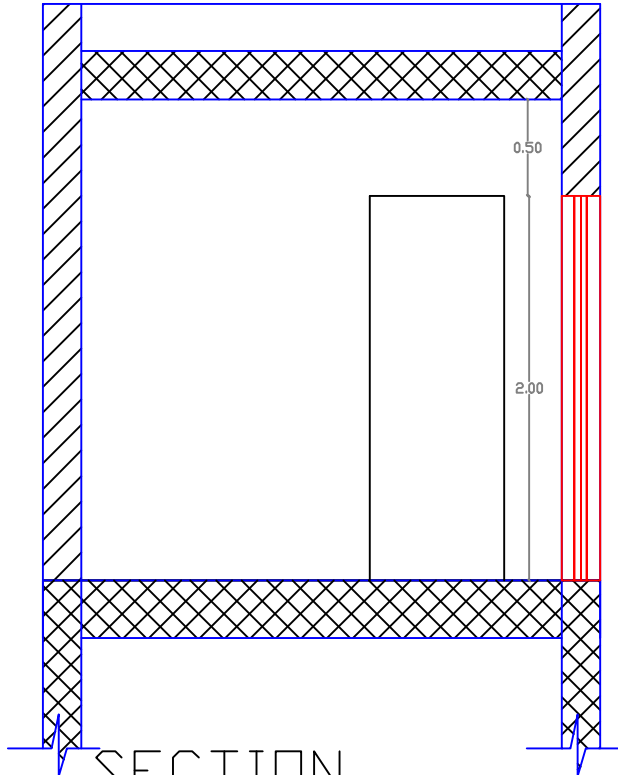

SECTION
B-B

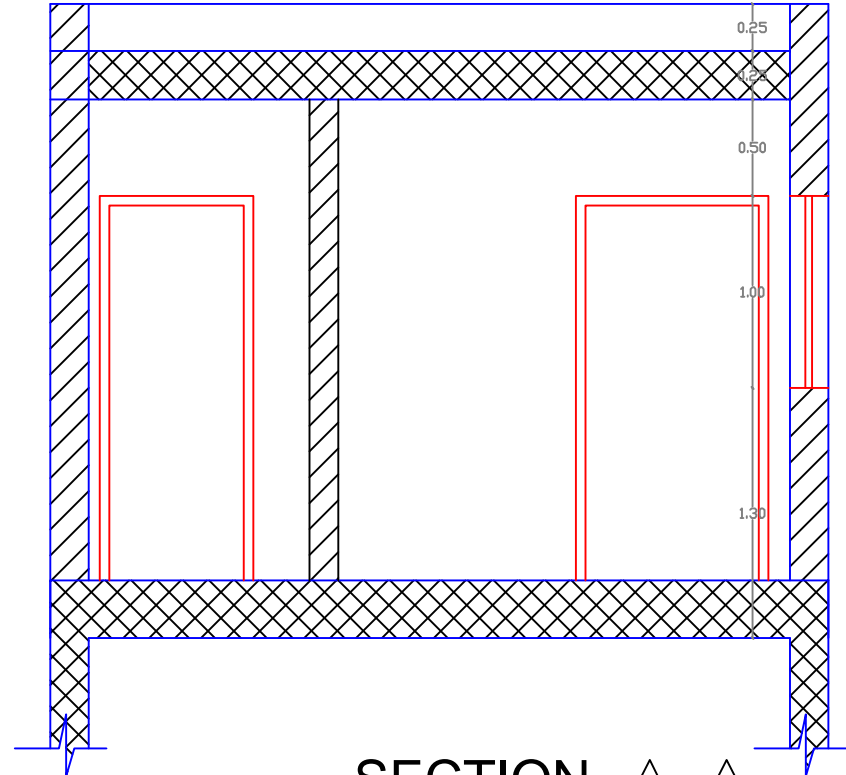

SECTION A-A



Rajef Security Room

Architectural plans

Scale: 1:50

Sheet No. 43

Section: Eng. Sa'ad Amarat

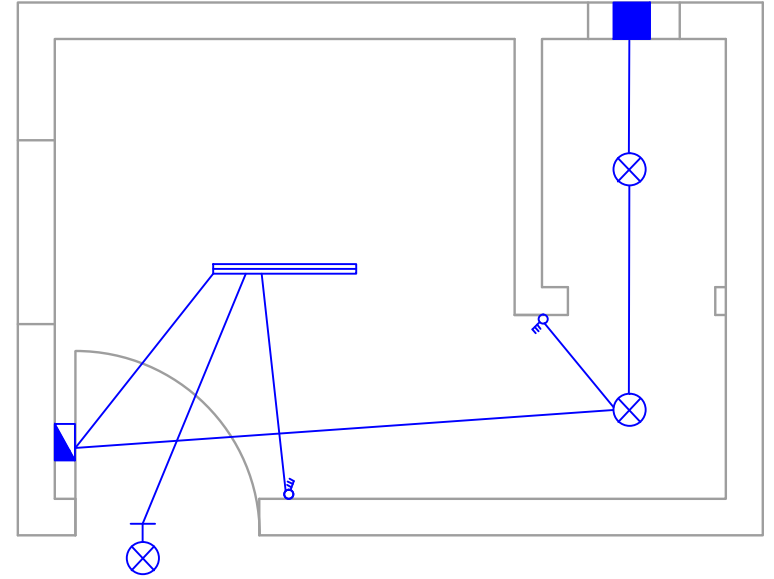
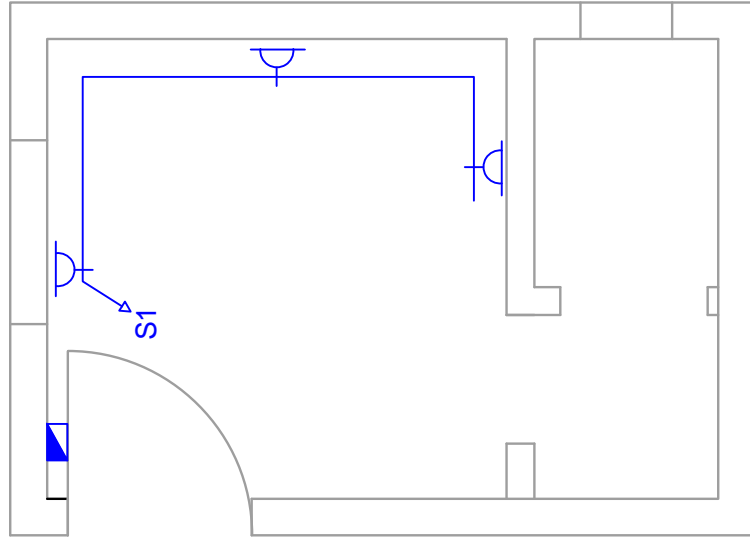

Petra

Petra Development & Tourism Region Authority

Raja Security Room

Electrical plan

DATE	DESIGNED BY	APPROVED BY
10/10/2020	Saleh Al-Rawafah	

Plan
 Eng. Saleh Al-Rawafah

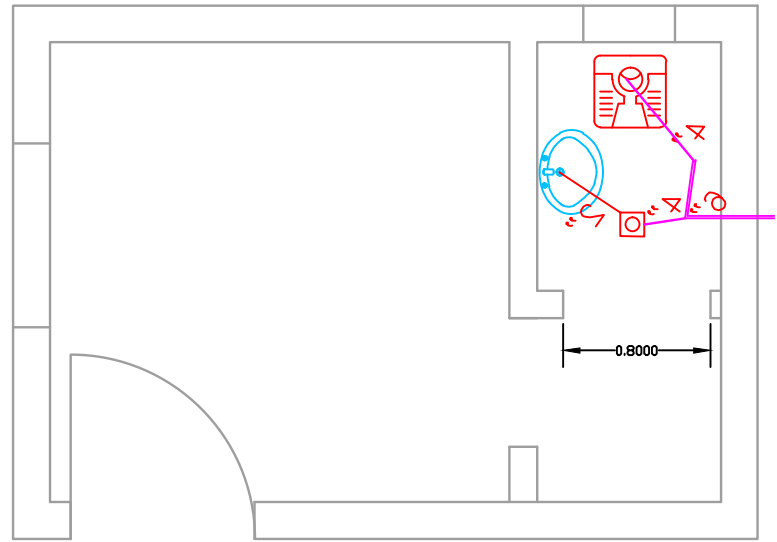
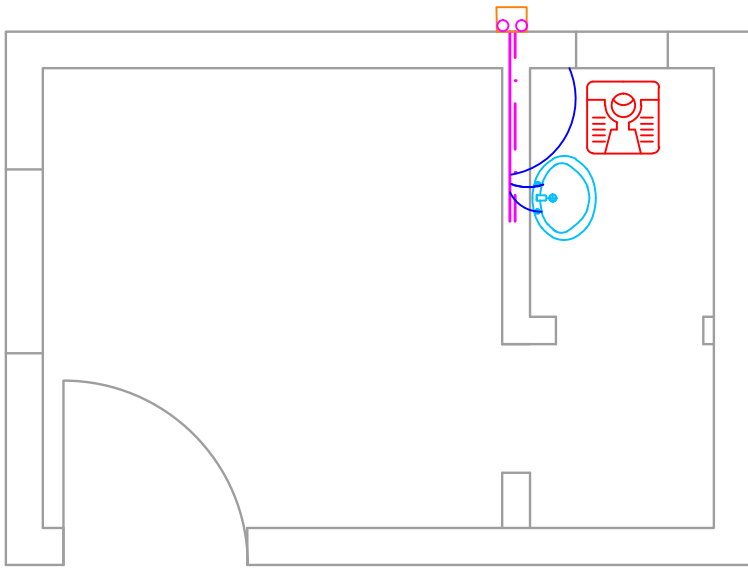

Petra

Petra Development & Tourism Region Authority

Refuge Security Room

MECHANICAL PLAN

Mechanical plans

DATE	REVISION	BY	NO.

PLAN	
------	--

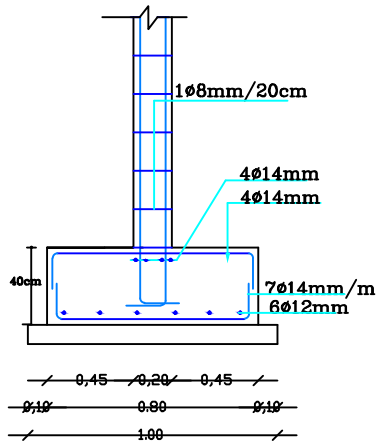

SEC. IN A-1

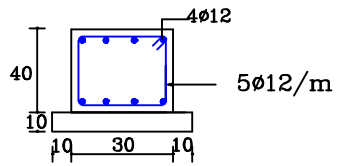

SEC. a-a

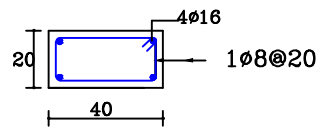

SEC. IN COLUMN C1

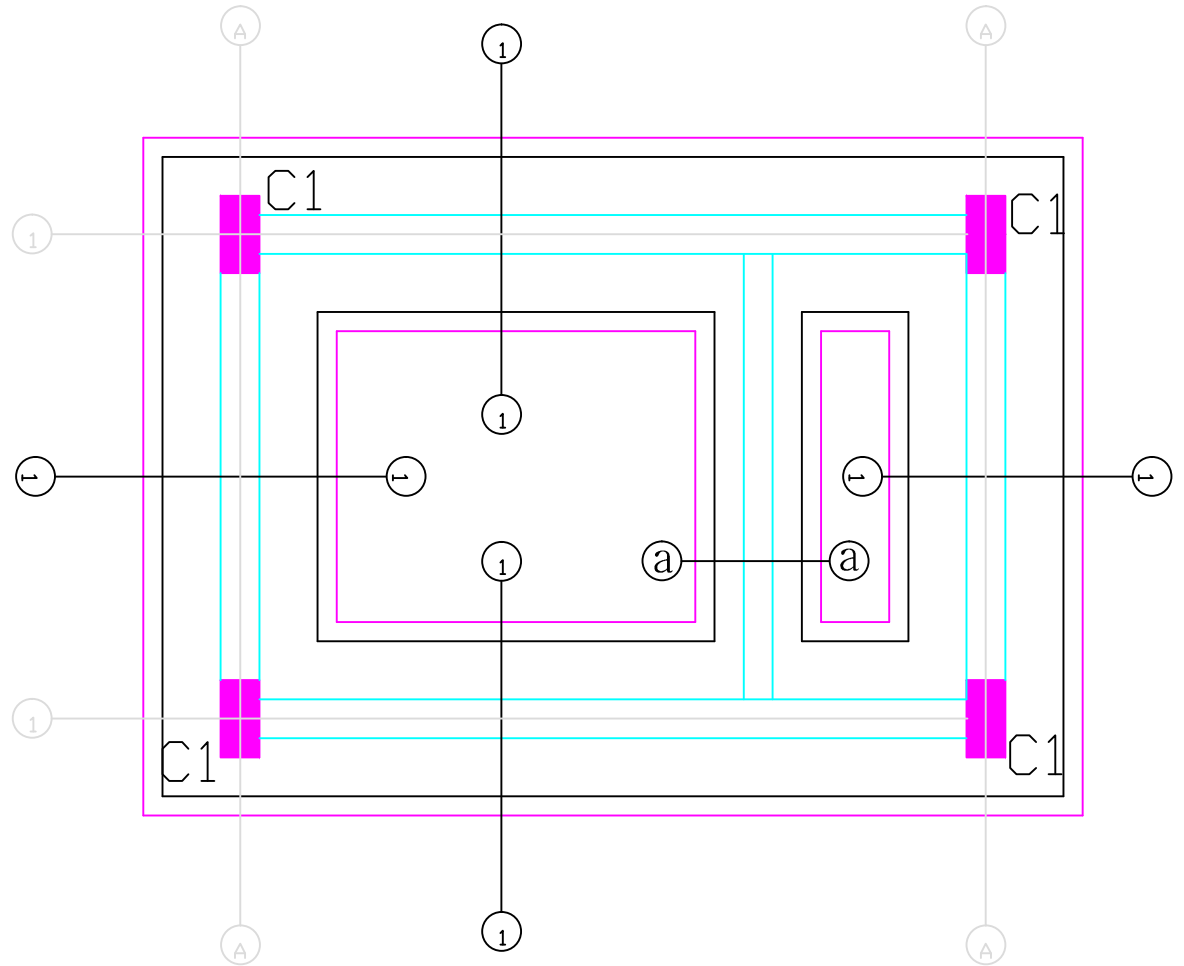

Petra
Petra Development & Tourism Region Authority

Rajaf Security Room

REVISION TITLE
Civil plans

NO	REVISION	DATE	BY	CHK
1	REVISION			

PLAN

Eng. Mervaha Parajul

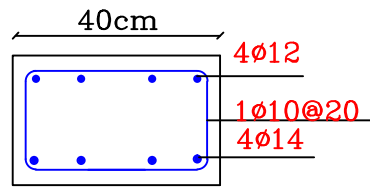
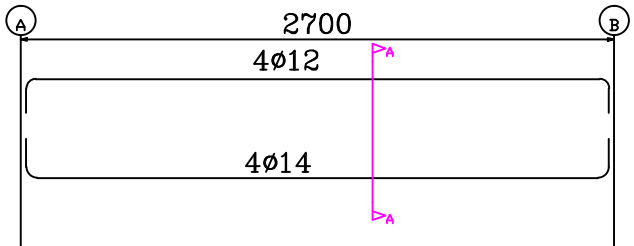

SECTION A-A

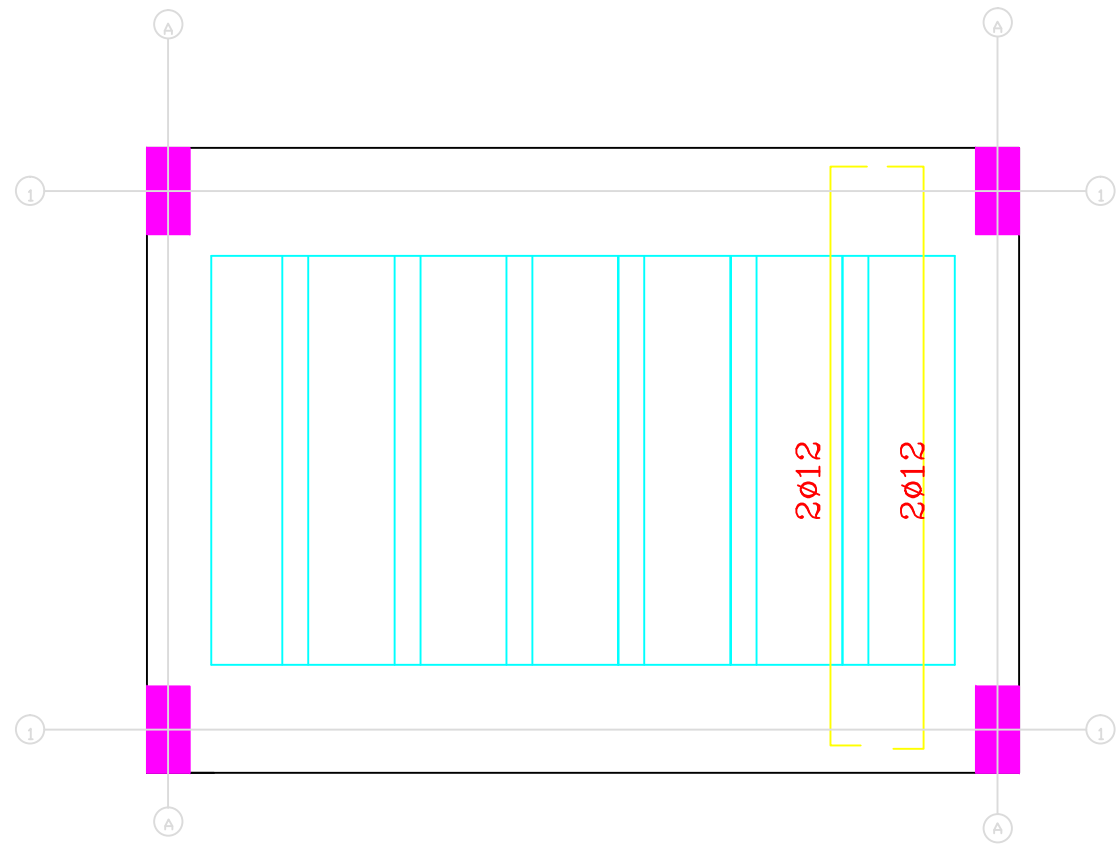

Rajaf Security Room

PROJECT TITLE:
Civil plans

SCALE	DATE	REVISION NO.
1:50		C 2

Plan
Eng. Montaha Parafat

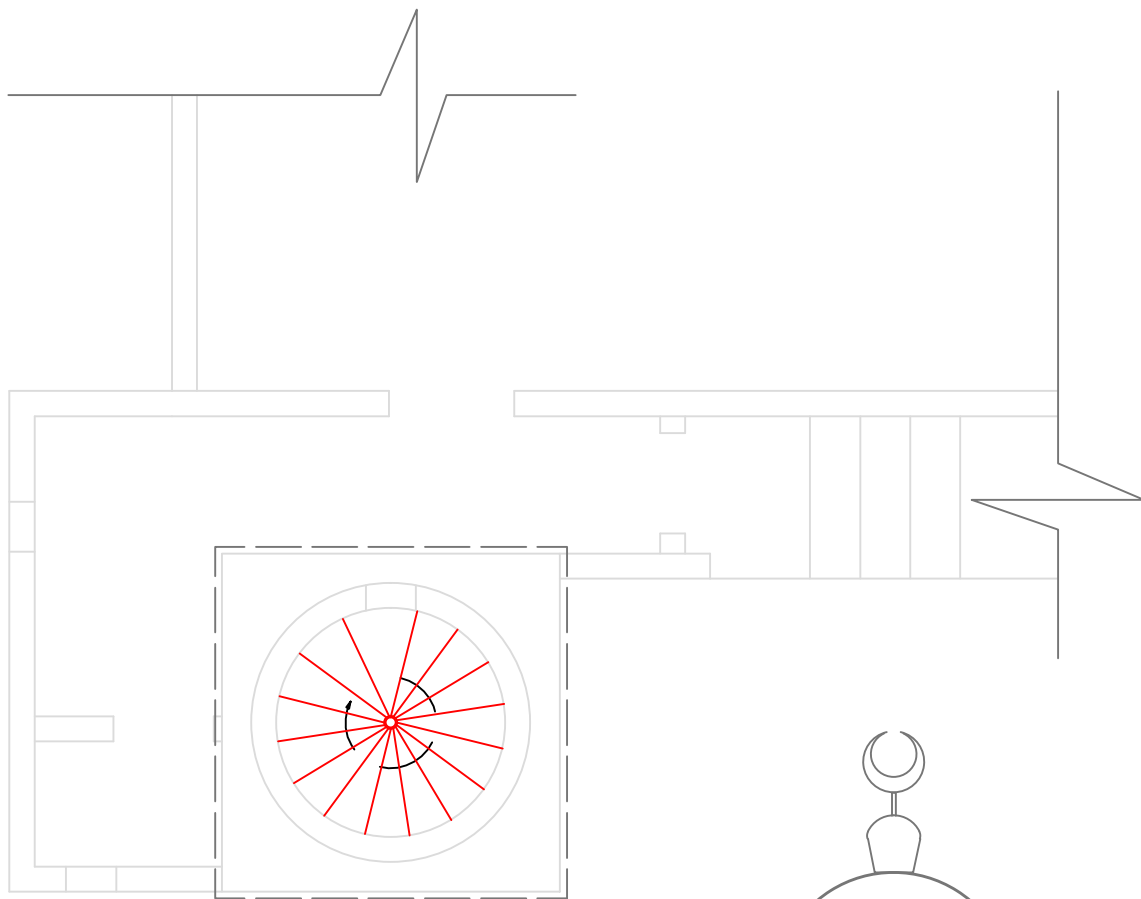

Plan

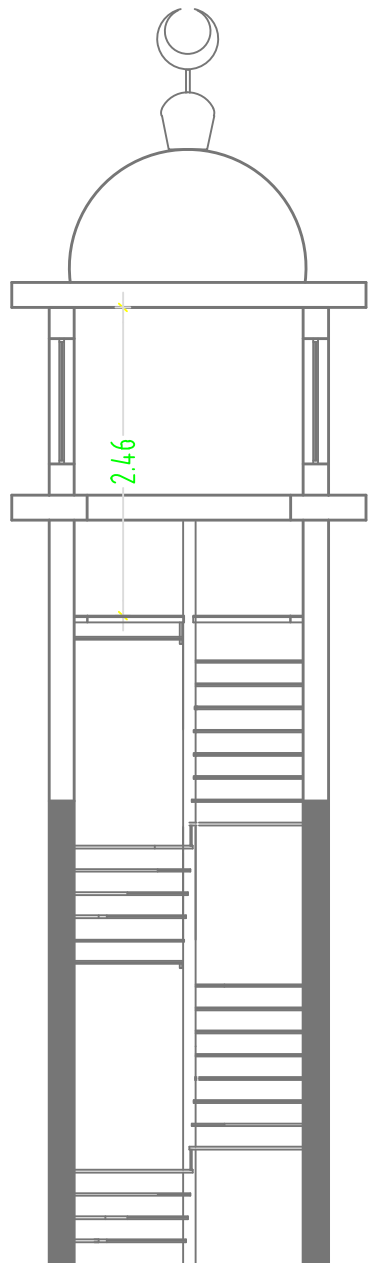

Section

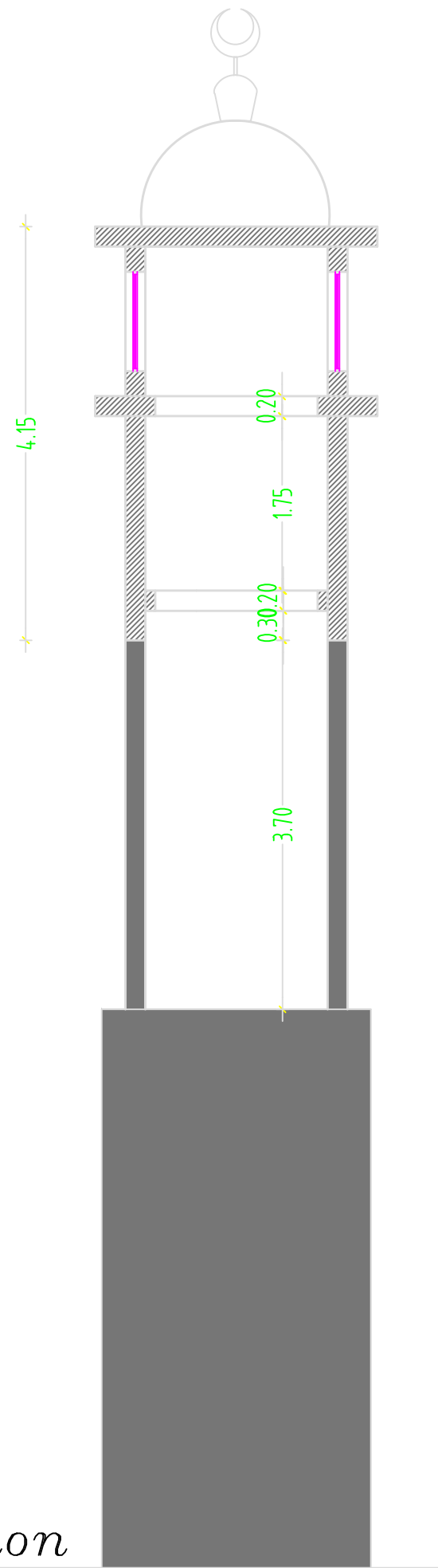

Rajef

Architectural plans

1:500 A 1

Plan Section

Eng . Safaa Amarat

SECTION A-A
SECTION B-B

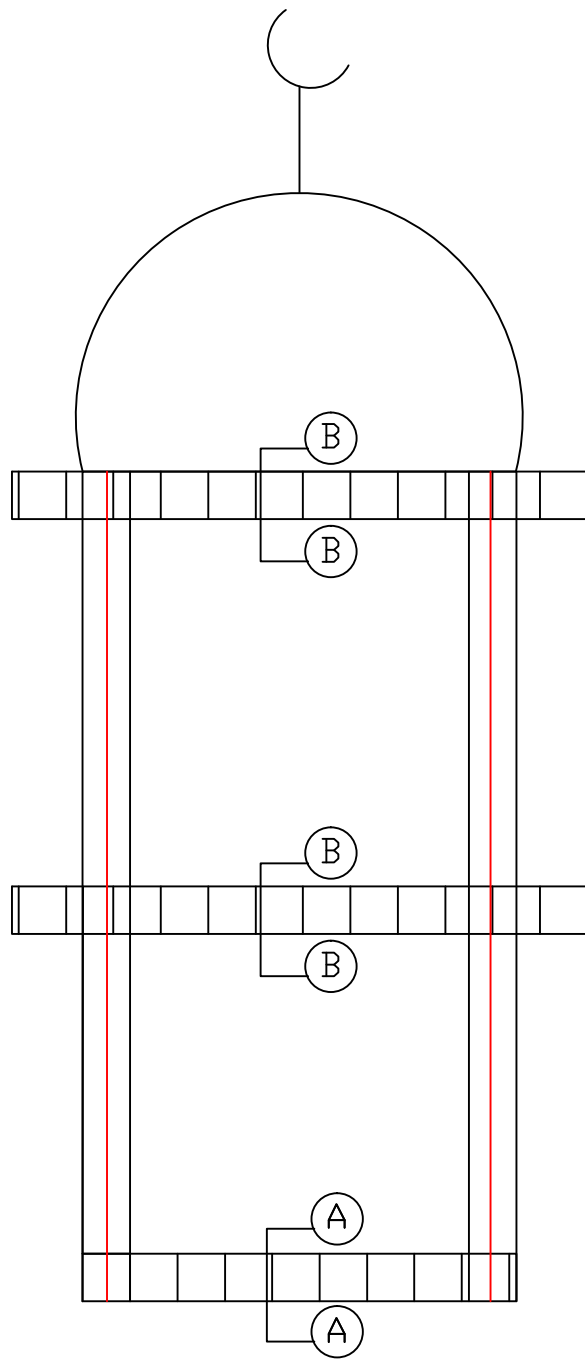
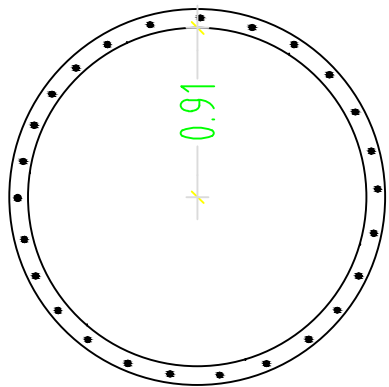

Petra

Petra Development & Tourism Region Authority

Rajef

DRAWING TITLE:
Civil plans

SCALE: 1:100 Dimensions: IN (m) DRAWING NO. c 1

Eng . Omran abo Darwish