

PRODUCED BY AN AUTODESK EDUCATIONAL PRODUCT

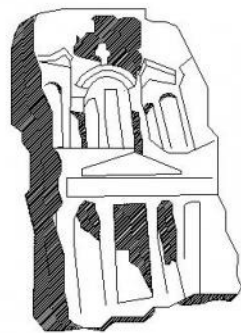

Petra

Petra Development & Tourism Region Authority

***Petra Development & Tourism
Region Authority***

*Rainwater drainage project
Rajef*

2017

PRODUCED BY AN AUTODESK EDUCATIONAL PRODUCT

PRODUCED BY AN AUTODESK EDUCATIONAL PRODUCT

PRODUCED BY AN AUTODESK EDUCATIONAL PRODUCT

PRODUCED BY AN AUTODESK EDUCATIONAL PRODUCT

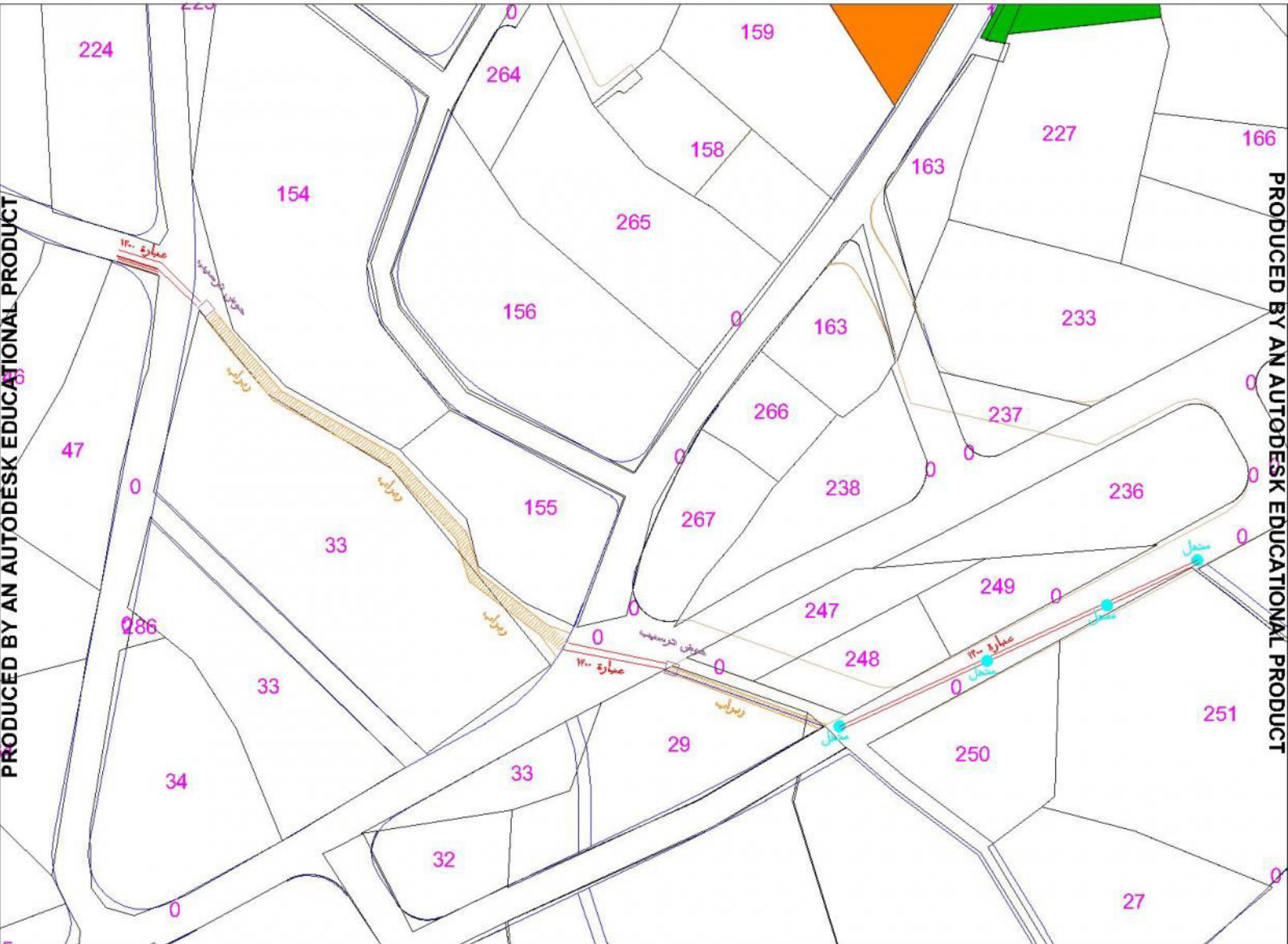

PRODUCED BY AN AUTODESK EDUCATIONAL PRODUCT

PRODUCED BY AN AUTODESK EDUCATIONAL PRODUCT

PRODUCED BY AN AUTODESK EDUCATIONAL PRODUCT

PRODUCED BY AN AUTODESK EDUCATIONAL PRODUCT

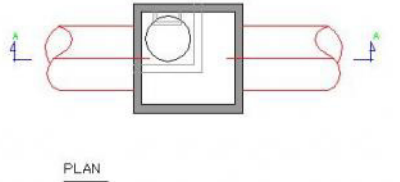
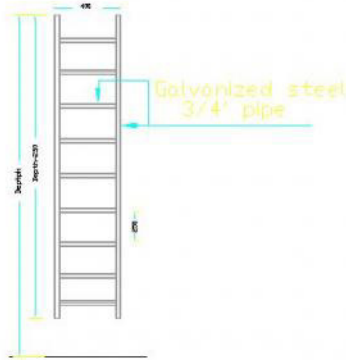
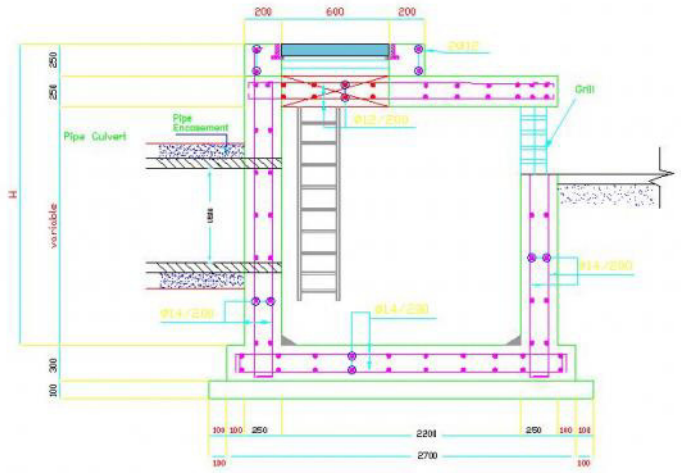
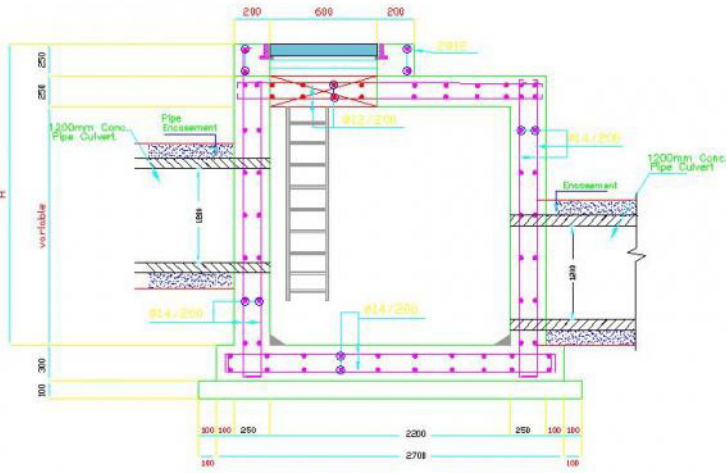

 Petra	
Petra Project	
Architect: Safaa Amarat	
Date: 11/2011	
Scale: 1/10	

PRODUCED BY AN AUTODESK EDUCATIONAL PRODUCT

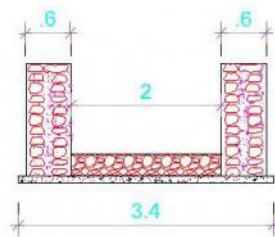
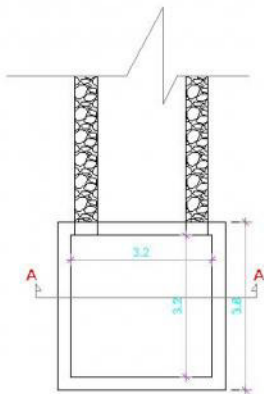

Rebrab Details

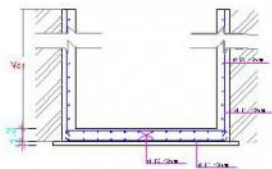

Sedimentation Tank Details

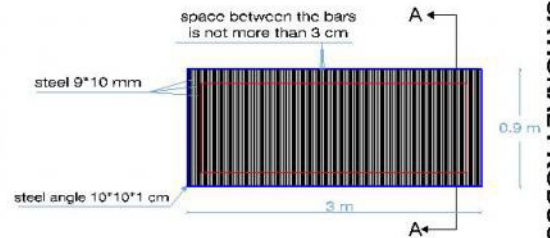
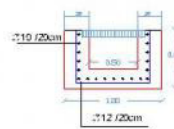
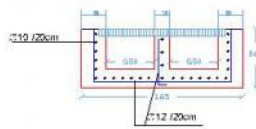

section B-B

section A-A

Grills Details



RainWater Drainage Project	
R.W.P	
MAJIN PISA	
Rebrab, Sedimentation Tank Details, Grills	
DESIGN	
DATE	DESIGNER
1438	M. H.
Aroh Safaa Amarat	

PRODUCED BY AN AUTODESK EDUCATIONAL PRODUCT

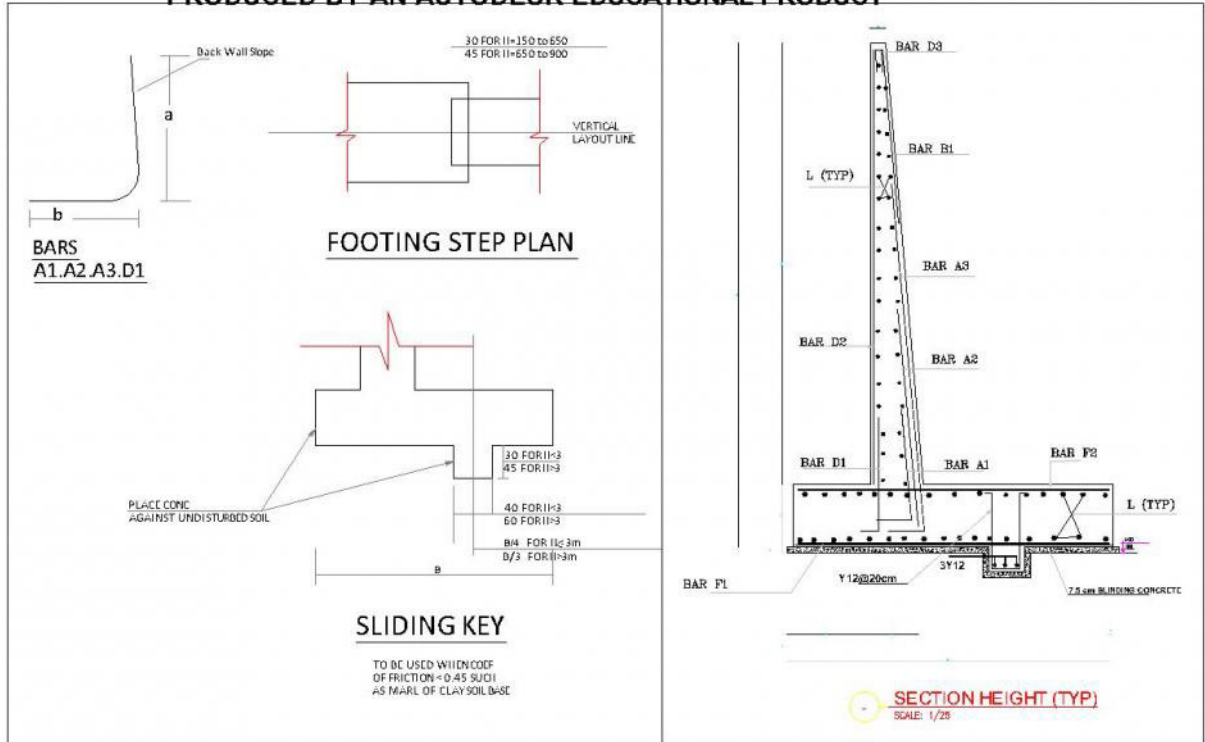

Dimension				Reinforcement																				Q _{all} (kN)		Q _{max} (kN)												
H	B	C	D	BAR A1					BAR A2					BAR A3					BAR D1					D2	B1	F1	F2	L	Q _{all} (kN)	Q _{max} (kN)								
C/W	C/W	C/W	C/W	0.00	0.00	0.00	0.00	0.00	0.00	0.00	0.00	0.00	0.00	0.00	0.00	0.00	0.00	0.00	0.00	0.00	0.00	0.00	0.00	0.00	0.00	0.00	0.00	0.00	0.00	0.00								
150	75	20	40	25																																		
200	120	25	40	25																																		
250	165	30	40	25																																		
300	170	40	40	30																																		
350	205	45	25	25																																		
400	240	50	80	30	30	45	40	40	30	30	45	37.5	20	20.5	30	45	28	30	27	11	7.5	20	9.5	11	15	25.5	30	45	25.5	11	15	20	48	2.11	1.07	1.62	800	
450	275	40	45	45	30	27.5	45	35	30	30	27.5	20	20	22	30	27.5	27	27	27	11	11.5	40	20	30	11	11.5	40	20	30	11	11.5	40	20	30	2.00	1.01	1.50	450
500	310	50	45	45	40	45	40	45	30	30	45	20	20	20	45	30	25	25	11	11	45	20	30	11	11	45	20	30	11	11	45	20	30	1.90	0.95	1.40	300	
550	340	55	50	20	45	31.5	31.5	28	20	45	22.5	25	20	20	45	30	25	25	11	11	50	20	30	11	11	45	20	30	11	11	45	20	30	1.80	0.90	1.35	250	
600	370	60	55	20	27.5	24	24	20	20	27.5	24.5	25	20	20	27.5	26	25	25	11	11.5	55	20	30	11	11	45	20	30	11	11	45	20	30	1.70	0.85	1.30	200	
650	405	65	60	25	45	30	30	25	25	45	26	25	20	20	45	30	25	25	11	11.5	60	20	30	11	11	45	20	30	11	11	45	20	30	1.60	0.80	1.25	150	
700	445	70	65	25	45	37.5	30	25	25	45	28	25	20	20	45	30	25	25	11	11.5	65	20	30	11	11	45	20	30	11	11	45	20	30	1.50	0.75	1.20	100	
750	470	75	65	25	27.5	24	24	20	20	27.5	24.5	25	20	20	27.5	26	25	25	11	11.5	70	20	30	11	11	45	20	30	11	11	45	20	30	1.40	0.70	1.15	750	
800	505	80	65	25	27.5	24	24	20	20	27.5	24.5	25	20	20	27.5	26	25	25	11	11.5	75	20	30	11	11	45	20	30	11	11	45	20	30	1.30	0.65	1.10	500	
850	540	85	70	25	27.5	24	24	20	20	27.5	24.5	25	20	20	27.5	26	25	25	11	11.5	80	20	30	11	11	45	20	30	11	11	45	20	30	1.20	0.60	1.05	250	
900	570	90	75	25	27.5	24	24	20	20	27.5	24.5	25	20	20	27.5	26	25	25	11	11.5	85	20	30	11	11	45	20	30	11	11	45	20	30	1.10	0.55	1.00	100	
950	600	95	80	25	27.5	24	24	20	20	27.5	24.5	25	20	20	27.5	26	25	25	11	11.5	90	20	30	11	11	45	20	30	11	11	45	20	30	1.00	0.50	0.95	50	
1000	630	100	85	25	27.5	24	24	20	20	27.5	24.5	25	20	20	27.5	26	25	25	11	11.5	95	20	30	11	11	45	20	30	11	11	45	20	30	0.90	0.45	0.90	0	

Petra

Arch Safan Amarat

PRODUCED BY AN AUTODESK EDUCATIONAL PRODUCT

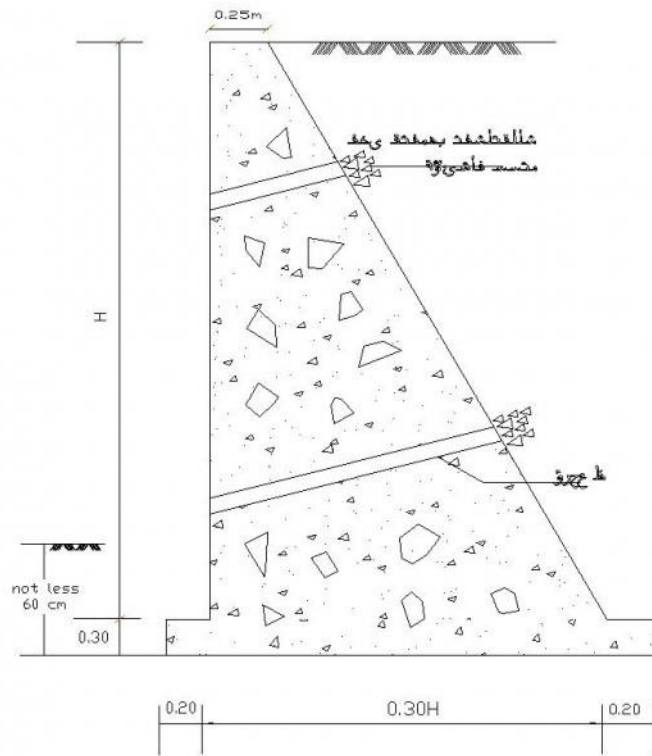

MASONRY RETAINING WALL - TYPICAL SEC.



RainWater Drainage Project مشروع تصريف مياه الأمطار	
MAJOR AREA مناطق البناء - TYPICAL SEC.	
DATE	DESIGNED BY
1/1/2020	Aroh Safaa Ameerat

PRODUCED BY AN AUTODESK EDUCATIONAL PRODUCT

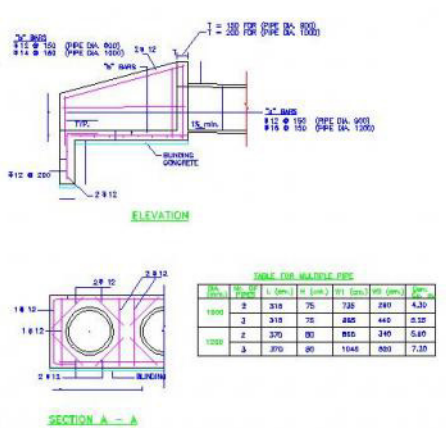
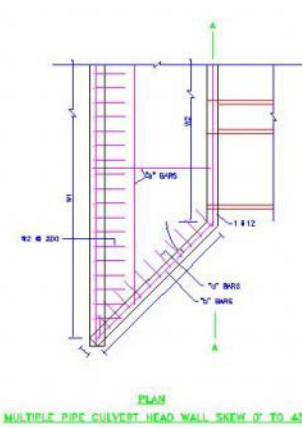
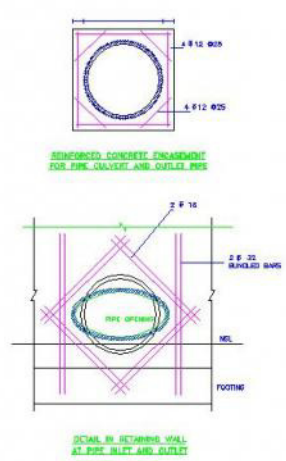
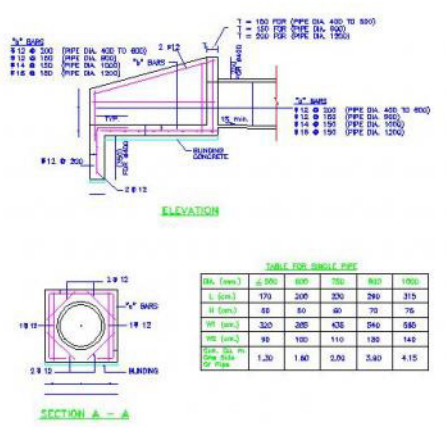
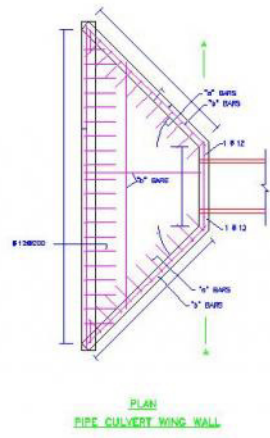
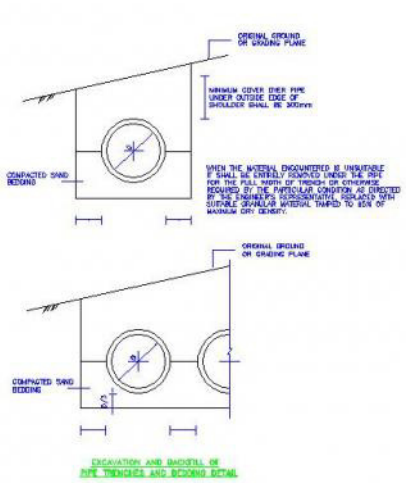

Petro

Water Management & Infrastructure Solutions

WaterWise Drainage Project
Rudra

MAHARASHTRA
STATE GOVT
PUNE COUNTRY
PLAN, SECTION & DETAILS

DATE: 15/05/2024
SCALE: 1:50

Aroh Sateja Amarat

PRODUCED BY AN AUTODESK EDUCATIONAL PRODUCT

PRODUCED BY AN AUTODESK EDUCATIONAL PRODUCT

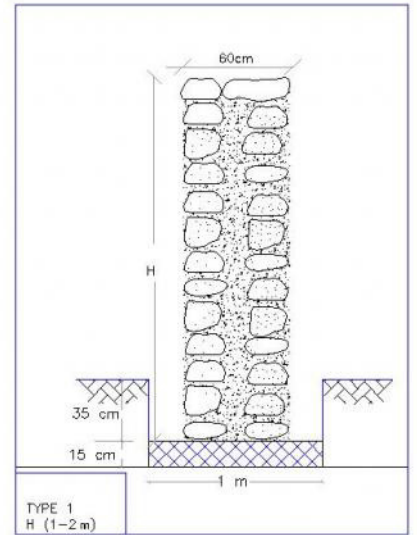
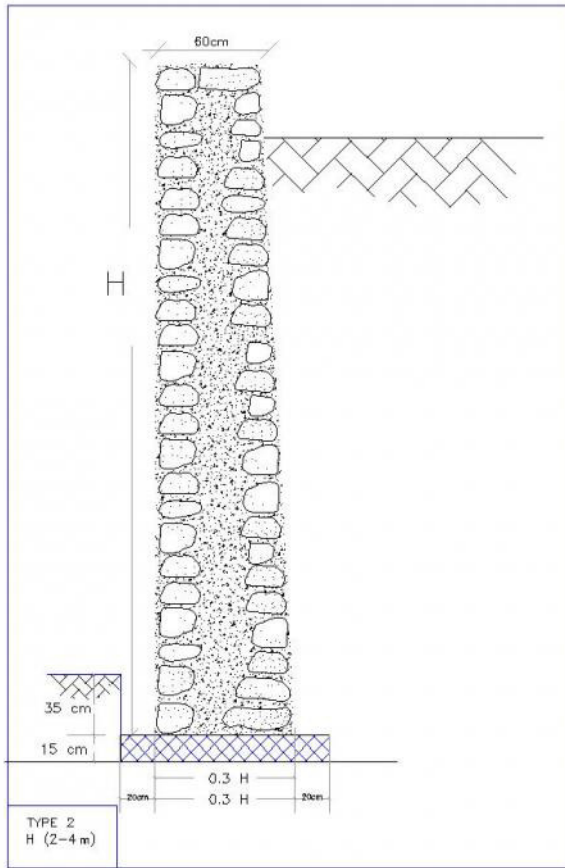

RainWater Drainage Project
Rajaf

STRUCTURE TITLE: walls

DATE: 11/01/2020

BY: Arch Sifan Amarat

SECTION: walls

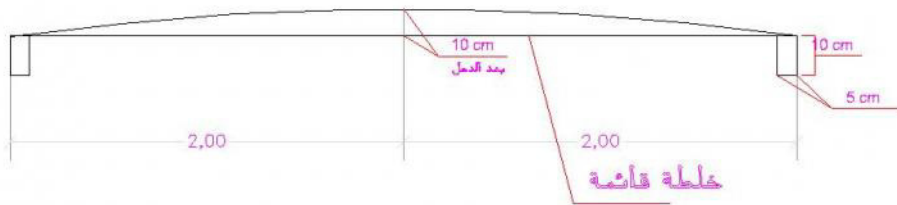
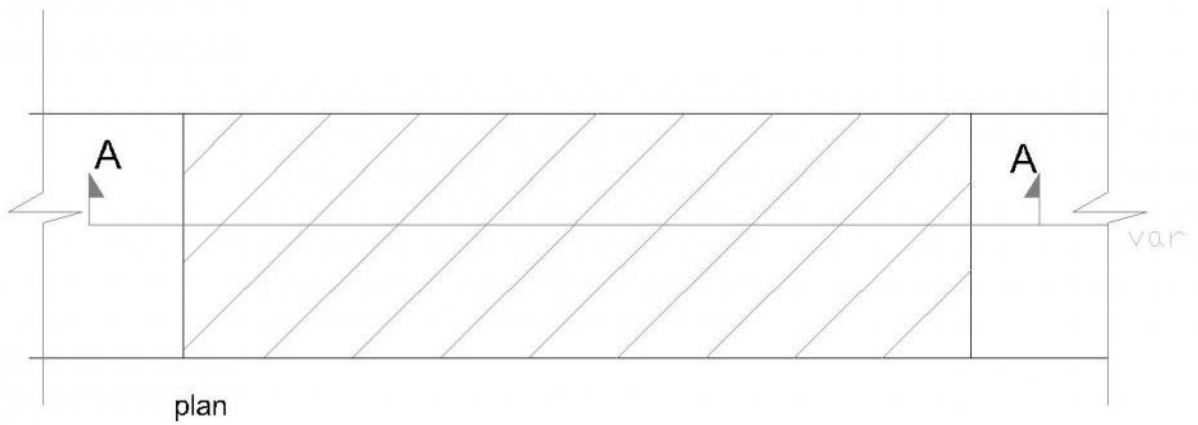

section A-A



Water Development & Tourism Authority

RainWater Drainage Project
Rwpj

PROJECT TITLE

DATE

BY (S)

DATE

BY (S)

DATE

BY (S)

DATE

BY (S)

DATE

BY (S)

DATE

BY (S)

DATE

BY (S)

DATE

BY (S)

DATE

BY (S)

DATE

BY (S)

DATE

BY (S)

DATE

BY (S)

DATE

BY (S)

DATE

BY (S)

DATE

BY (S)

DATE

BY (S)

DATE

BY (S)

DATE

BY (S)

DATE

BY (S)

DATE

BY (S)

DATE

BY (S)

DATE